

KENWOOD

LSF-1010

SPEAKER SYSTEM

INSTRUCTION MANUAL

KENWOOD CORPORATION

Before applying power

⚠ Caution : Read this section carefully to ensure safe operation.





Units are designed for operation as follows.

Europe and U.K. AC 230 V only

Safety precautions

⚠ Caution : Read this section carefully to ensure safe operation.

WARNING : TO PREVENT FIRE OR ELECTRIC SHOCK, DO NOT EXPOSE THIS APPLIANCE TO RAIN OR MOISTURE.

 <div style="border: 1px solid black; padding: 2px; text-align: center;"> CAUTION <small>RISK OF ELECTRIC SHOCK DO NOT OPEN</small> </div> 	<p>CAUTION: TO REDUCE THE RISK OF ELECTRIC SHOCK, DO NOT REMOVE COVER (OR BACK). NO USER-SERVICEABLE PARTS INSIDE. REFER SERVICING TO QUALIFIED SERVICE PERSONNEL.</p>
	<p>THE LIGHTNING FLASH WITH ARROWHEAD SYMBOL, WITHIN AN EQUILATERAL TRIANGLE, IS INTENDED TO ALERT THE USER TO THE PRESENCE OF UNINSULATED "DANGEROUS VOLTAGE" WITHIN THE PRODUCT'S ENCLOSURE THAT MAY BE OF SUFFICIENT MAGNITUDE TO CONSTITUTE A RISK OF ELECTRIC SHOCK TO PERSONS.</p>
	<p>THE EXCLAMATION POINT WITHIN AN EQUILATERAL TRIANGLE IS INTENDED TO ALERT THE USER TO THE PRESENCE OF IMPORTANT OPERATING AND MAINTENANCE (SERVICING) INSTRUCTIONS IN THE LITERATURE ACCOMPANYING THE APPLIANCE.</p>

Unpacking

Unpack the unit carefully and make sure that all accessories are put aside so they will not be lost.

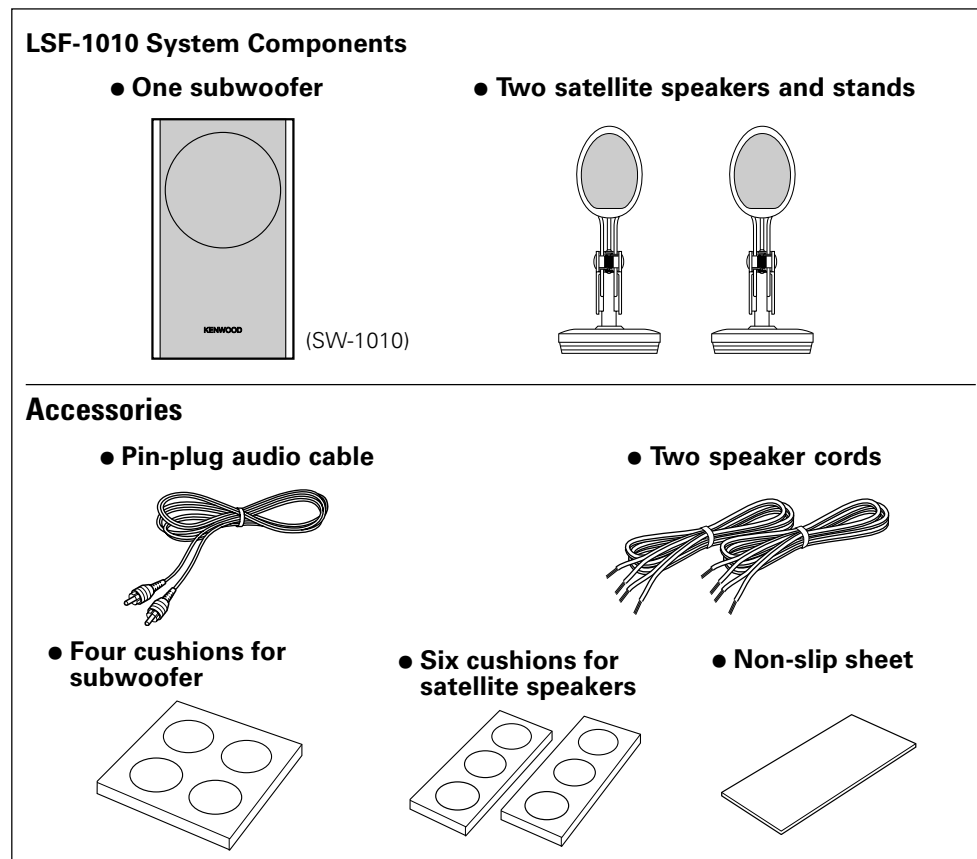

Examine the unit for any possibility of shipping damage. If your unit is damaged or fails to operate, notify your dealer immediately. If your unit was shipped to you directly, notify the shipping company without delay. Only the consignee (the person or company receiving the unit) can file a claim against the carrier for shipping damage. We recommend that you retain the original carton and packing materials for use should you transport or ship the unit in the future.

Keep this manual handy for future reference.



Contents

Caution : Read the pages marked  carefully to ensure safe operation.

Introduction	2
 Before applying power	2
 Safety precautions	2
Unpacking	3
IMPORTANT SAFEGUARDS	4
Location and Orientation	6
Setting Up the Satellite Speakers	8
Making Connections	10
Components and Their Functions	14
Important Operating Notes	15
Adjusting the Satellite Speaker Position	16
Other Ways to Set Up the Satellite Speakers	18
Maintenance	23
Troubleshooting	24
Specifications	25

 **Caution : Read this page carefully to ensure safe operation.**

Please read all of the safety and operating instructions before operating this appliance. Adhere to all warnings on the appliance and in the instruction manual. Follow all the safety and operating instructions. These safety and operating instructions should be retained for future reference.

- 1. Power sources** – The appliance should be connected to a power supply only of the type described in the instruction manual or as marked on the appliance. If you are not sure of the type of power supply to your home, consult your appliance dealer or local power company. For appliances intended to operate from battery power, or other sources, refer to the instruction manual.
- 2. Power-cord protection** – Power-supply cords should be routed so that they are not likely to be walked on or pinched by items placed upon or against them, pay particular attention to cords at plugs, and the point where they exit from the appliance.
- 3. CAUTION – Polarization** – This appliance may be equipped with a polarized alternating-current line plug (a plug having one blade wider than the other). This plug will fit into the power outlet only one way. This is a safety feature. If you are unable to insert the plug fully into the outlet, try reversing the plug. If the plug should still fail to fit, contact your electrician to replace your obsolete outlet. Do not defeat the safety purpose of the polarized plug.
- 4. Ventilation** – Slots and openings in the cabinet are provided for ventilation and to ensure reliable operation of the appliance and to protect it from overheating, and these openings must not be blocked or covered. The appliance should be situated so that its location or position does not interfere with its proper ventilation.
To maintain good ventilation, do not put records or a table cloth on the appliance. Place the appliance at least 10 cm away from the walls.
Do not use the appliance on a bed, sofa, rug or similar surface that may block the ventilation openings. This appliance should not be placed in a built-in installation such as a bookcase or rack unless proper ventilation is provided or the manufacturer's instructions have been adhered to.

- 5. Water and moisture** – The appliance should not be used near water – for example, near a bathtub, washbowl, kitchen sink, laundry tub, in a wet basement, or near a swimming pool, etc.
- 6. Temperature** – The appliance may not function properly if used at extremely low, or freezing temperatures. The ideal ambient temperature is above +5°C (41°F).
- 7. Heat** – The appliance should be situated away from heat sources such as radiators, heat registers, stoves, or other appliances (including amplifiers) that produce heat.
- 8. Electric shock** – Care should be taken so that objects do not fall and liquid is not spilled into the enclosure through openings. If a metal object, such as a hair-pin or a needle, comes into contact with the inside of this appliance, a dangerous electric shock may result. For families with children. Never permit children to put anything, especially metal, inside this appliance.
- 9. Enclosure removal** – Never remove the enclosure. If the internal parts are touched accidentally, a serious electric shock might occur.
- 10. Cleaning** – Unplug this appliance from the wall outlet before cleaning. Do not use volatile solvents such as alcohol, paint thinner, gasoline, or benzine, etc. to clean the cabinet. Use a clean dry cloth.
- 11. Lightning** – For added protection for this appliance during a lightning storm, or when it is left unattended and unused for long periods of time, unplug it from the wall outlet and disconnect the antenna or cable system. This will prevent damage to the appliance due to lightning and power-line surges.
- 12. Abnormal odor** – If abnormal odor or smoke is detected, immediately turn the power OFF and unplug the appliance from the wall outlet. Contact your dealer or nearest service center.

 **Caution : Read this page carefully to ensure safe operation.**

13. Damage requiring service – The appliance should be serviced by qualified service personnel when:

- A.** The power-supply cord or the plug has been damaged.
- B.** Objects have fallen, or liquid has been spilled, into the appliance.
- C.** The appliance has been exposed to rain or water.
- D.** The appliance does not appear to operate normally by following the instruction manual. Adjust only those controls that are covered by the instruction manual as an improper adjustment of other controls may result in damage and will often require extensive work by a qualified technician to restore the appliance to its normal operation.
- E.** The appliance has been dropped, or the enclosure damaged.
- F.** The appliance exhibits a marked change in performance.

14. Abnormal smell – If an abnormal smell or smoke is detected, immediately turn the power OFF and unplug the appliance from the wall outlet. Contact your dealer or nearest service center.

15. Power lines – An outside antenna system should not be located in the vicinity of overhead power lines or other electric light or power circuits, or where it can fall into such power lines or circuits. When installing an outside antenna system, extreme care should be taken to keep from touching such power lines or circuits as contact with them might be fatal.

16. AC outlets – Do not connect other audio equipment with a power consumption larger than that specified to the AC outlet on the rear panel. Never connect other electrical appliances, such as an iron or toaster, to it to prevent fire or electric shock.

17. Overloading – Do not overload wall outlets, extension cords, or integral convenience receptacles as this can result in a risk of fire or electric shock.

18. Attachment – Do not use attachments not recommended by the appliance manufacturer as they may cause hazards.

19. Replacement parts – When replacement parts are required, be sure the service technician has used replacement parts specified by the manufacturer or have the same characteristics as the original parts. Unauthorized substitutions may result in fire, electric shock, or other hazards.

20. Safety check – Upon completion of any service or repairs to this appliance, ask the service technician to perform safety checks to determine that the appliance is in proper operating condition.

Satellite Speakers

For standard setup, mount each speaker to a stand as described below.

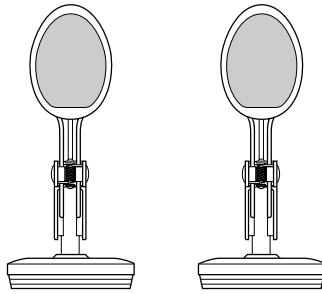

For detail, see page 8 “Setting Up the Satellite Speakers”

Subwoofer

The subwoofer can be positioned either vertically or horizontally.

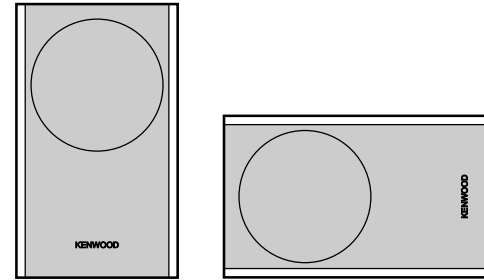

Vertical Orientation

Horizontal Orientation

⚠ CAUTION
Be sure to unplug the speaker before changing the orientation.

Attaching the Cushions

Attach four cushions to the base of the subwoofer, one at each corner, as shown below. The cushions prevent the subwoofer from sliding, and dampen its vibrations. (Cushions are included in the package.)

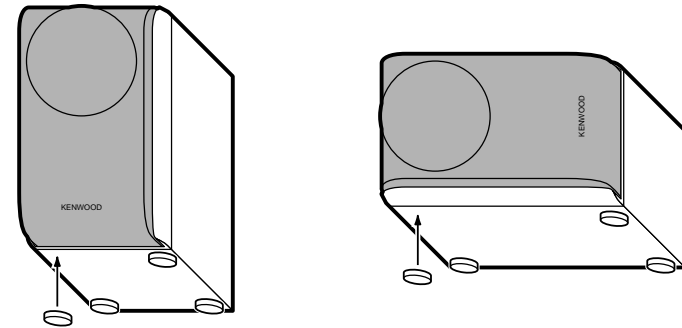

- You can position the subwoofer vertically or horizontally.

Location Precautions

Interference with AM Reception

The subwoofer utilizes digital circuitry to provide efficient signal amplification. Placing the subwoofer too close to your AM receiver (AM tuner) may therefore cause interference with AM reception. If you notice noise in your AM reception, you can correct the problem by moving the subwoofer farther from the receiver.

- The subwoofer will not produce interference if its power is off or if its volume is set to minimum level. If interference occurs under these conditions, the problem lies elsewhere.
- If you are using a freestanding indoor antenna (such as a loop antenna) with your AM device, keep the antenna (and antenna wires) as far as possible from the subwoofer (and subwoofer wires).

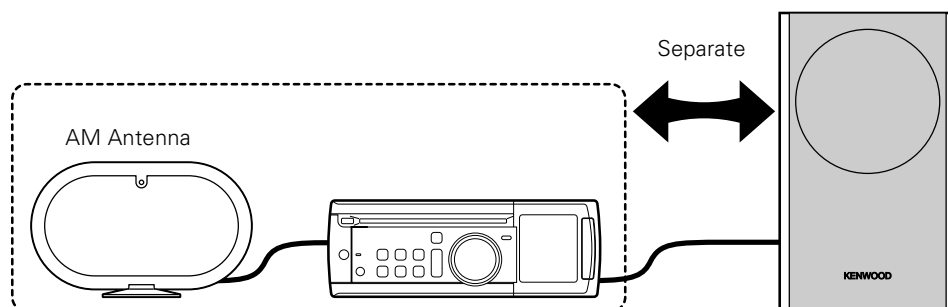

Subwoofer and Satellite Speaker Magnetic Shielding and TV Color Reception

The speakers (subwoofer and satellite speaker) include magnetic shielding and can therefore be installed close to a TV set. If installing close to a TV, however, be sure to follow the procedure below. This will allow the TV's automatic degaussing feature to correct for any magnetic field generated by the speakers. Neglecting to set the speakers up according to this procedure may result in color distortion on the TV.

- ① Switch off all power to the TV.
- ② Set up the speakers, and then wait at least 30 minutes before switching the power to the TV back on.

If color irregularities occur even after you have followed the steps above, move the speakers farther from the TV.

- If using the speakers close to your TV, keep it well separated from other magnetic sources. Interaction of an external magnet with the speakers may produce distortion in TV color.
- Electromagnetism generated by the TV may cause the speakers to produce sound even while the stereo or AM device connected to it is off. You can correct the problem by moving the speakers farther from the TV.

Feedback (Howling)

Installing the subwoofer too close to an analog record player may result in howling, caused by feedback of sound into the player. You can correct the problem by reducing the subwoofer volume or by moving the subwoofer further from the player.

In rare cases, feedback may also occur with cassette decks or with CD, minidisk, and DVD players, producing howling or other types of sound or image distortion. Again, you can correct the problem by reducing the subwoofer volume or moving the subwoofer.

CAUTION (SUBWOOFER only)

To ensure adequate ventilation and prevent risk of fire or damage from overheating, please observe the following.

- Never place objects that would impair heat release onto the top of the unit.
- Leave adequate open space on all sides. Minimum required open space at each side (measuring from the greatest protection is as follows.)

Top panel : 50 cm

Side panel : 10 cm

Back panel : 10 cm

8 Setting Up the Satellite Speakers

LSF-1010 (EN)

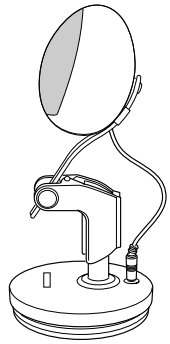

For standard setup, mount each speaker to a stand as described below.

As an alternative to the standard setup, it is also possible to mount the speakers onto a wall or to set them up without the stand. For information about setup alternatives, see page 18, "Other Ways to Set Up the Satellite Speakers."

FIRST: Attach speaker cord.

Connect speaker cord to the terminals on the bottom of the stand base.

① Use a coin or screwdriver to turn loosen the screws.

② Remove the plastic insulation from each wire tip, and twist the exposed metal wire.

③ Curl the wire around the thin part of the corresponding screw, and then tighten the screw.

Be sure that the screw head makes contact with metal only, not with plastic insulation.

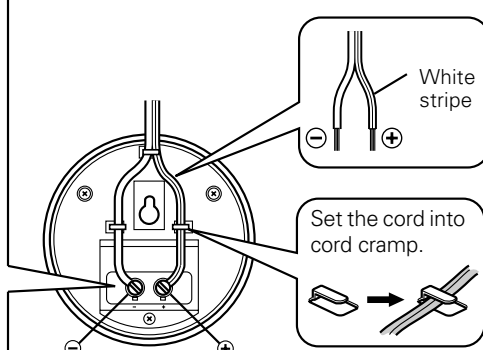

White stripe

Set the cord into cord clamp.

1. Attach the speaker to the arm.

Use the speaker screw and washer removed from the satellite speaker to make the attachment.

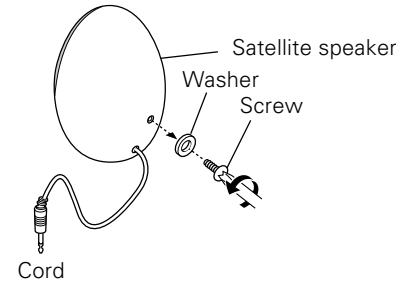

① Remove the screw and washer from the rear of the satellite speaker.

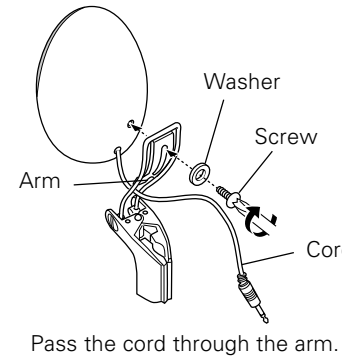

② Pass the cord through the arm.

③ Use the screw and washer to fasten the speaker to the arm.

Adjusting the Speaker Angle

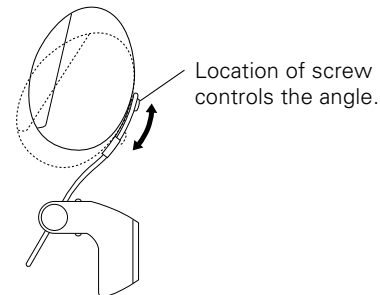

You can adjust the angle of the speaker by moving the screw to a different location on the arm.

2. Attach the arm to the stand.

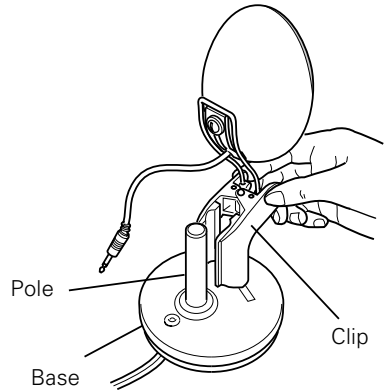

Push the clip open (see illustration) and fit onto the pole.

3. Plug the speaker cord into the base of the stand.

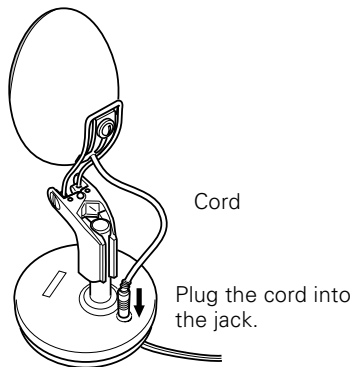

Plug the cord extending from the speaker into the jack on the base of the stand.

You can adjust the position of the speaker by changing the height and angle of the arm as desired. See "Adjusting the Satellite Speaker Position" on page 16.

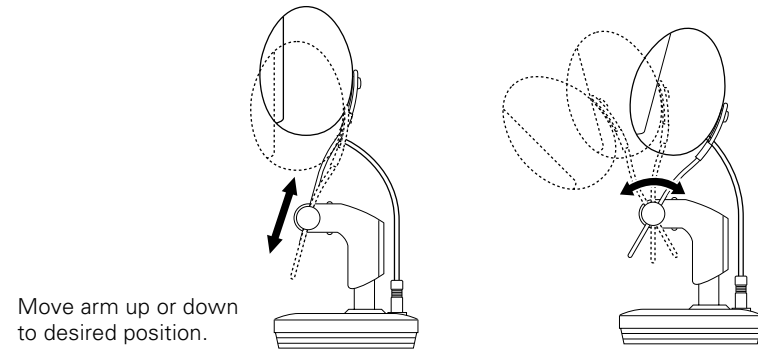

Before Connecting...

You can connect the subwoofer to your amplifier or receiver in any of three ways, as described below. Refer to the indicated page for connection instructions.

1. If your amp or receiver includes a SUBWOOFER PRE-OUT jack:

For connection instructions, see page 11, "Connecting to Amp's SUBWOOFER PRE-OUT Jack."

2. If your amp or receiver does not include a SUBWOOFER PRE-OUT jack:

In this case, you can connect to the speaker output terminals on your amp or receiver. For instructions, see page 12, "Connecting to Amp's Speaker Output Terminals."

3. If your amp or receiver includes standard PRE-OUT jacks:

It is also possible to connect to standard PRE-OUT jacks on your amp or receiver. For instructions, see page 13, "Connecting to Amp's Standard PRE-OUT Jacks."

- It is also possible to connect the subwoofer's LINE IN jacks to the REC OUT or LINE OUT jacks on the amp or receiver. If you make this type of connection, however, volume adjustments at the amp side will not affect the volume from the subwoofer. Again, see page 13, "Connecting to Amp's Standard PRE-OUT Jacks."

Subwoofer

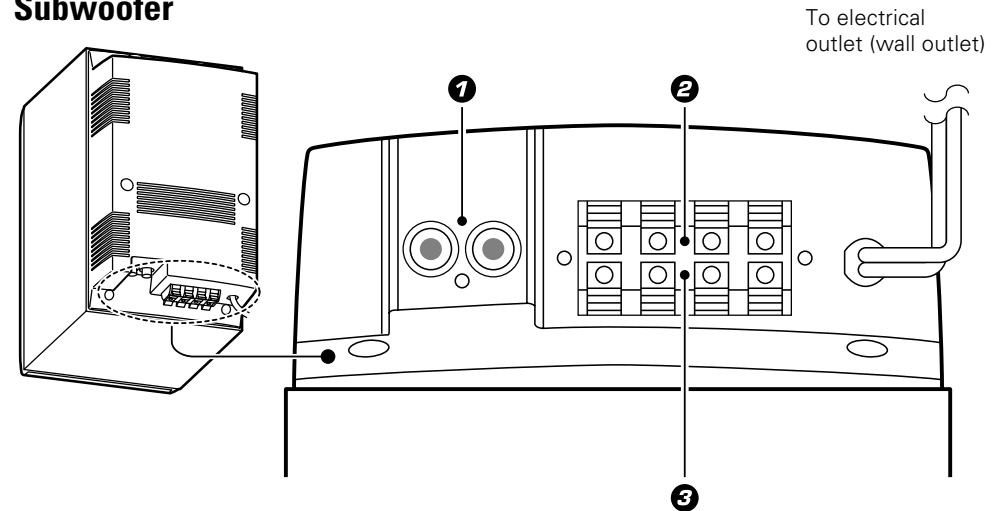

❶ LINE IN jacks

Connect to the SUBWOOFER PRE-OUT output or other line-level output on your amplifier or receiver.

❷ FROM AMPLIFIER terminals

Connect to the speaker output terminals on your amplifier or receiver.

❸ TO SPEAKER terminals

These terminals output the signal received at the FRONT AMPLIFIER terminals. You can use them to relay the signal to your front speakers.

CAUTION

Do not plug in the power cord until you have finished making all connections.



1. Be sure to connect all cables securely. Insecure connections may result in distortion or noise.
2. Always unplug the power cord before connecting or disconnecting cables. Leaving the power plugged in while making connections may result in malfunction or damage.
3. Never short the (+) and (-) speaker wires together.
4. Do not reverse L and R or (+) and (-) sides when making connections. Reversal of sides or polarities may result in unnatural, incorrectly positioned sound.
5. Please read the documentation that came with the devices you are connecting to, and make connections accordingly.

Connecting to Amp's SUBWOOFER PRE-OUT Jack

Using the pin-plug audio cable that came with the subwoofer, connect the SUBWOOFER PRE-OUT jack on your amplifier or receiver to the L/ (MONO) LINE IN jack on the subwoofer.

CAUTION
Do not plug in the power cord until you have finished making all connections.

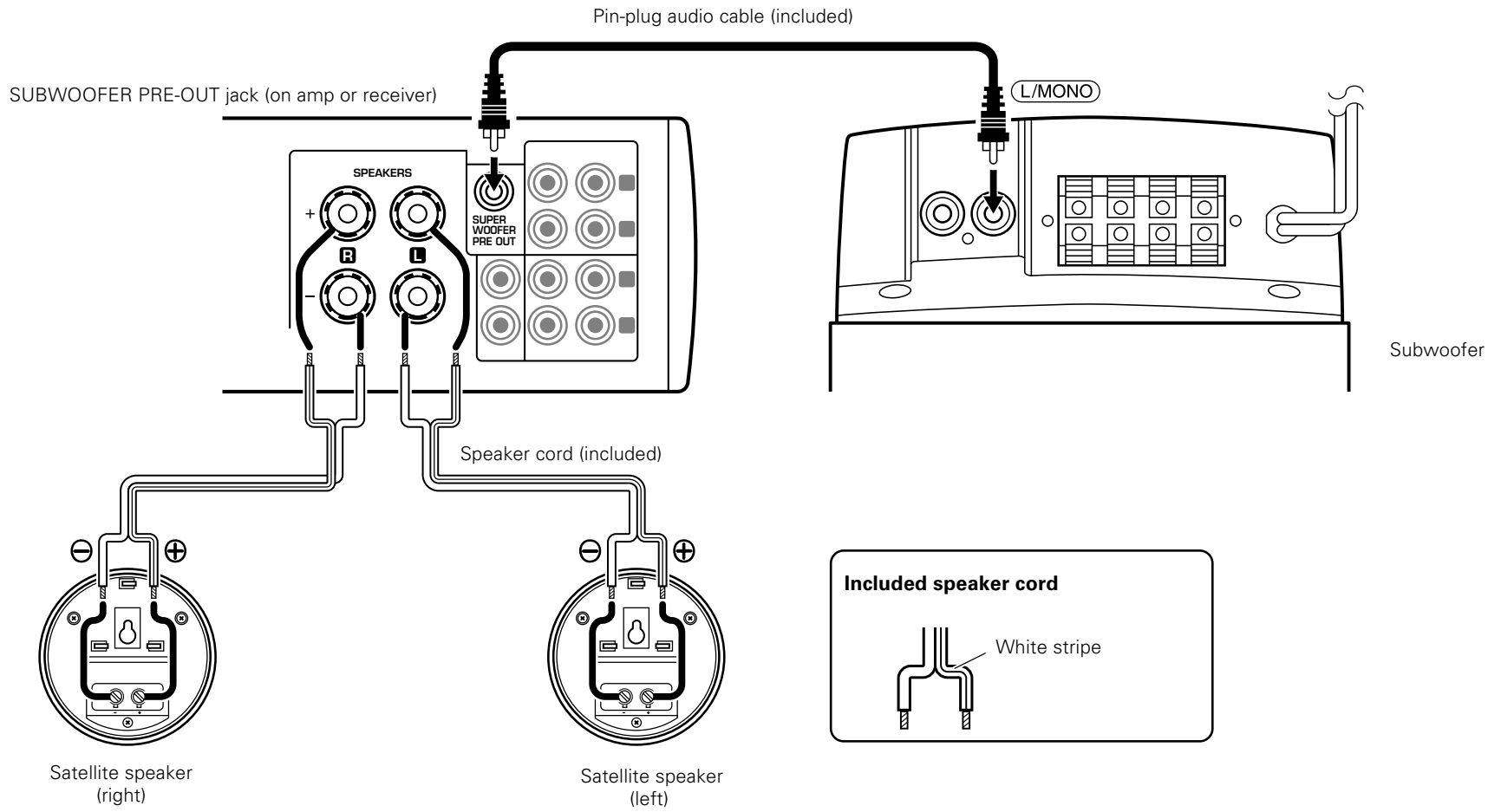

Connecting to Amp's Speaker Output Terminals

Connect the FROM AMPLIFIER terminals on the subwoofer to the speaker output terminals on your amplifier or receiver. Connect the TO SPEAKERS terminals on the subwoofer to your front speakers. Make all connections using speaker cord.

Speaker cord for the connection between the amp and the subwoofer is not included. Please purchase this cord separately.

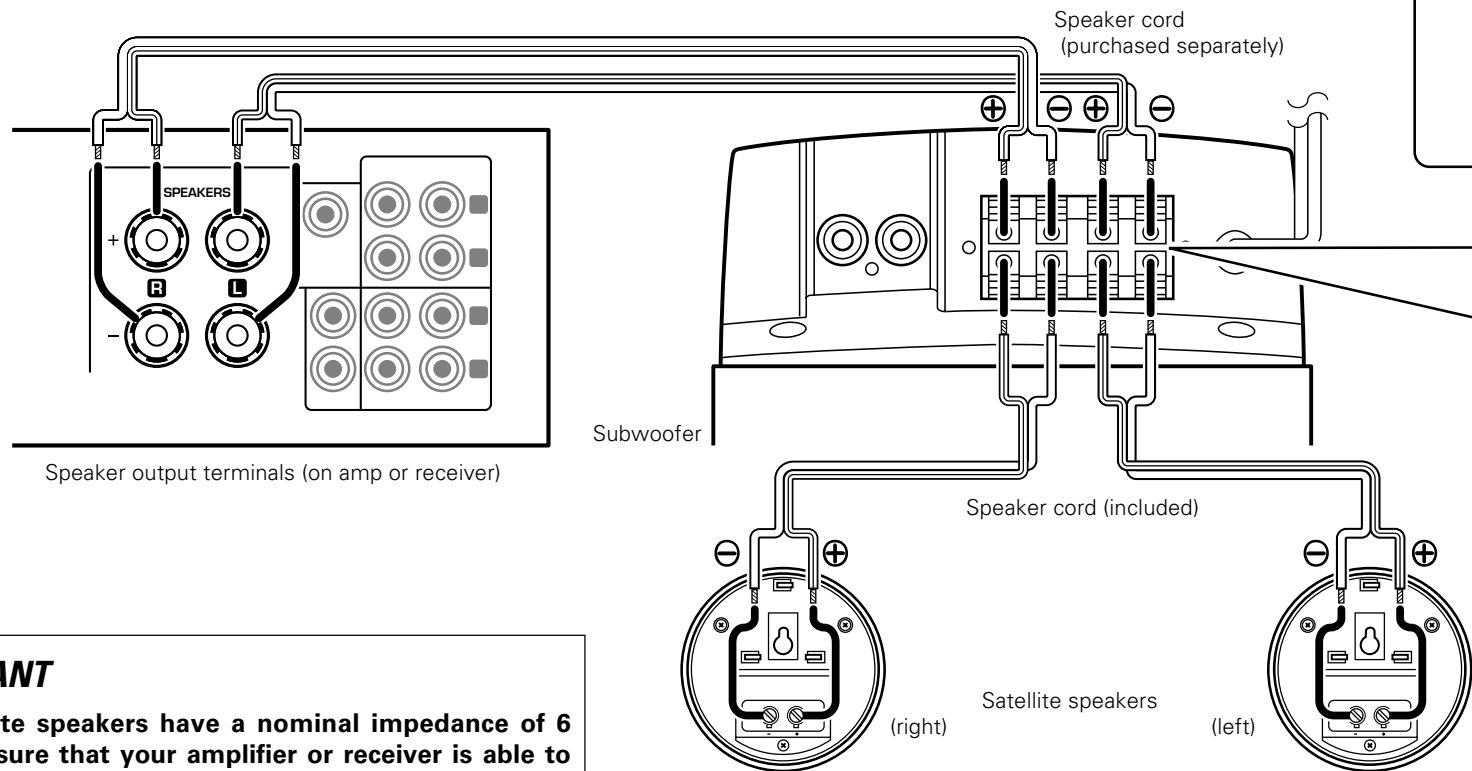

IMPORTANT

The satellite speakers have a nominal impedance of 6 ohms. Be sure that your amplifier or receiver is able to work with 6-ohm speakers.



If your amplifier or receiver has two sets of speaker output terminals, you can connect the front speakers directly to the second set of terminals (rather than connecting them to the TO SPEAKER terminals on the subwoofer).

Connecting to Amp's Standard PRE-OUT Jacks

Connect the PRE-OUT jacks on the amp or receiver to the LINE IN jacks on the subwoofer. Make the connection using pin-plug audio cable. (The cable is not included with the subwoofer.)

CAUTION

Do not plug in the power cord until you have finished making all connections.

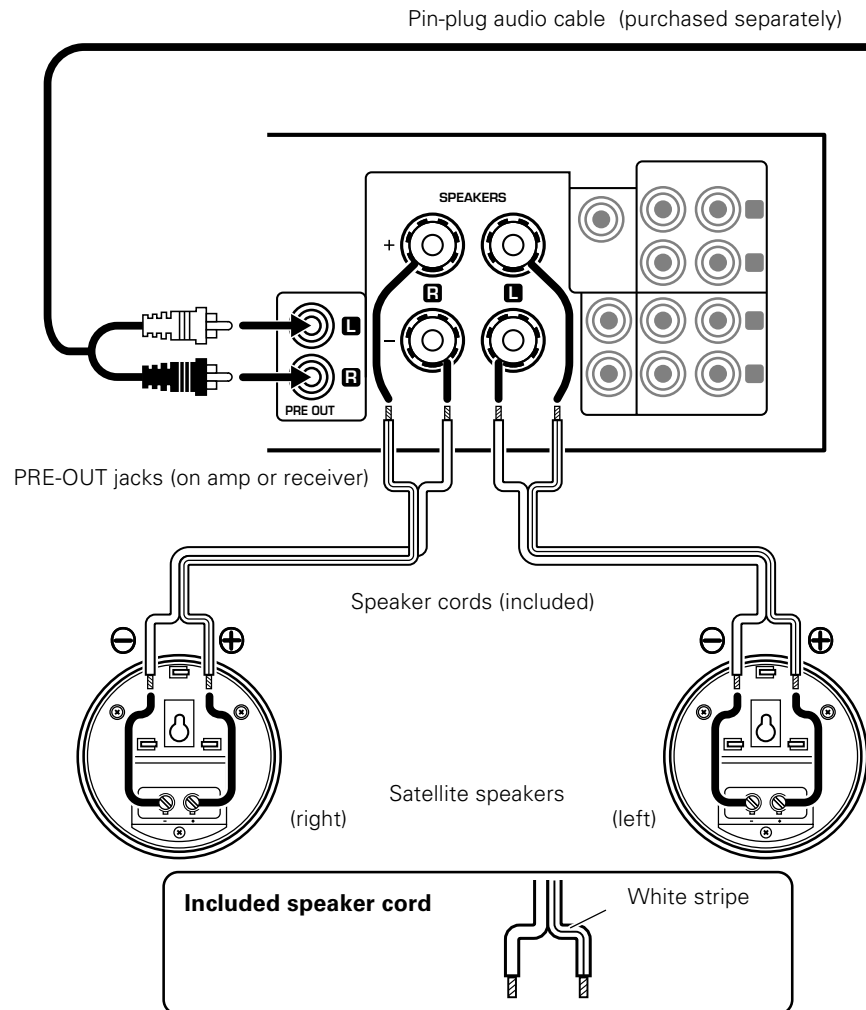

Note About Pin-Plug Cables

Some commercially available pin-plug cables have relatively plug ends that may become bent if the subwoofer is installed vertically. Bending of plugs may cause internal wires to break, resulting in loss of sound. If installing the subwoofer vertically, be sure to use pin-plug cables with short plugs.



- It is also possible to connect the subwoofer's LINE IN jacks to the REC OUT or LINE OUT jacks on the amp or receiver (using the same cable as described here). If you make this type of connection, however, volume adjustments at the amp side will not affect the volume from the subwoofer. This means that you will need to manually adjust the subwoofer volume each time you adjust the volume at the amp side.
- If you wish to connect the subwoofer to the PRE-OUT jacks on a standalone preamplifier, the preamp unit must include a second set of terminals for connection to speaker amps, and must be capable of simultaneous output to both the PRE-OUT jacks and the speaker-amp jacks.

Subwoofer

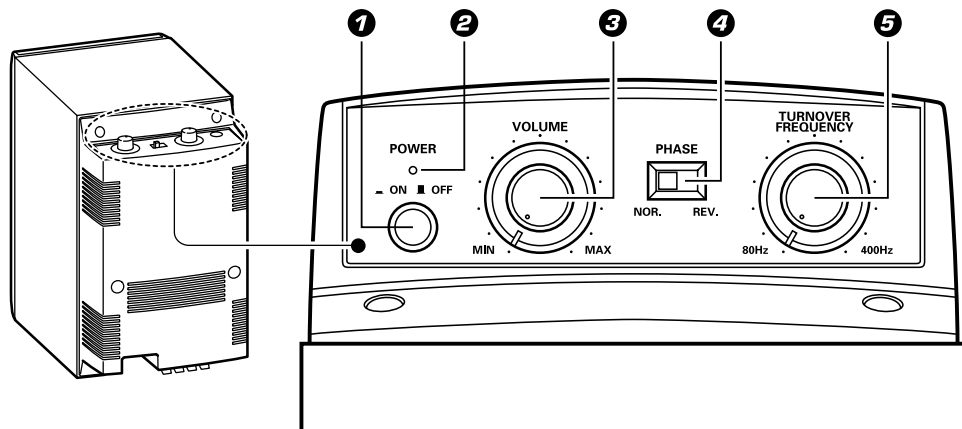

- ❶ **POWER switch**
Press this switch to set the subwoofer's power on or off.
- ❷ **POWER indicator**
Indicator lights up when power is on.
- ❸ **VOLUME adjuster dial**
- ❹ **PHASE switch**
- ❺ **TURNOVER FREQUENCY adjuster dial**

Adjusting the Sound

The **VOLUME**, **TURNOVER FREQUENCY**, and **PHASE** controls allow you to adjust the sound in accordance with the room acoustics, the subwoofer location. Please adjust the controls so that you get optimal sound at the room location at which you normally listen.

1. Adjusting the Volume

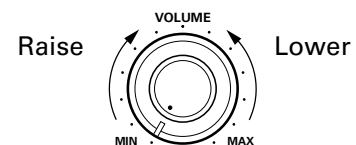

Adjust the volume by turning the **VOLUME** dial. Adjust so that you get a good balance with satellite speakers.

2. Adjusting the Turnover Frequency

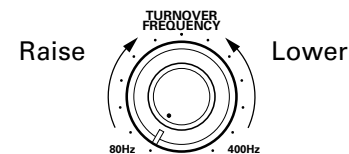

Use the **TURNOVER FREQUENCY** dial to adjust the cutoff frequency (the highest frequency reproduced by the subwoofer). Again, adjust so that you get a good balance with satellite speakers. Appropriate adjustment depends on the type of the sound you are reproducing (musical genre, movie soundtrack, etc.).

3. Switching the Phase

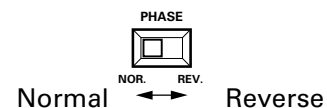

Try switching the phase if you encounter either of the following problems.

- If the interaction of subwoofer and speakers is producing an unnatural bass.
- If the bass volume at the room location at which you normally listen seems unnaturally low, possibly as a result of the room acoustics or the positioning of the subwoofer.

Satellite Speakers

1. The satellite speakers have a nominal impedance of 6 ohms. To ensure safe and efficient speaker operation, be sure that your amplifier or receiver is able to work with 6-ohm speakers.
2. The speaker system's power capacity is indicated in the specifications. Do not operate speakers at power levels above this limit. Doing so may result in damage to the speakers.

Subwoofer

1. If supplying a high-level signal, do not over-boost the bass at the amplifier or receiver side. (Avoid excessive use of the amp's bass control and other loudness adjusters.)
2. Turn the subwoofer volume to its minimum level when making major changes to the sound input (for example, when first switching on the amplifier or when first dropping the needle onto a record).

16 *Adjusting the Satellite Speaker Position*

LSF-1010 (EN)

You can adjust the position of the speaker by changing the height and angle of the arm.

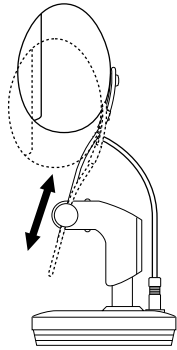

Adjusting the arm height

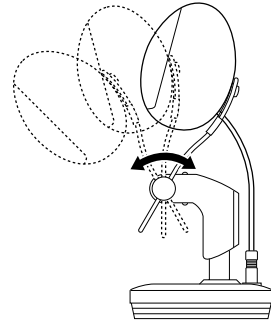

Adjusting the arm angle

Getting Ready to Adjust

Loosen the two arm screws holding the arm in place (one screw on each side of the arm), so that you can move the arm up and down.

1. Remove the screw cap covering each arm screw.

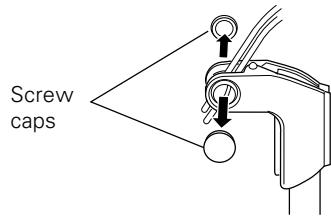

Screw caps

To remove each cap, grasp it at the circumference and peel it off.

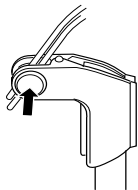

To replace the cap, place it over the screw head and lightly press it along the circumference.

2. Loosen the two screws.

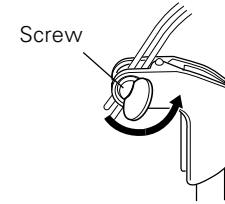

Use a coin to turn the screws (one screw on each side).

Use a coin to turn each screw.

- Once you have loosened both screws you will be able to move the arm up and down, or to remove it entirely.

Adjusting the Arm Height

Move the arm up or down to raise or lower the speaker.

1. Loosen the two arm screws as described above, so that the arm can move up and down.

2. Raise or lower the arm to the desired height, then retighten the two screws.

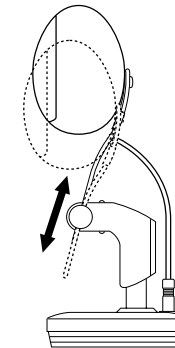

Move arm up or down to desired position.

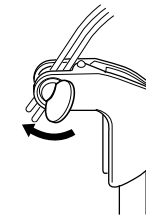

Use a coin to retighten the screws.

3. Replace the screw caps.

You may now want to readjust the angle of the speaker on the arm. You can do this by loosening the screw holding the speaker to the arm, repositioning the screw, and then retightening it. See "Adjusting the Speaker Angle," on page 8.

Adjusting the Arm Angle

You can set the arm to any of five different angles by adjusting the angle of the arm holders.

1. Remove the arm.

Remove the arm.

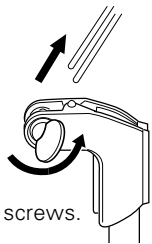

Loosen the screws.

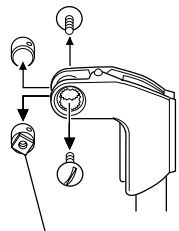

Arm holders

Remove the screws from the arm holders.

- ① Loosen the two arm screws (one screw on each side of the arm) and pull the arm out.
 - Unplug the cord from the jack before removing the arm.
- ② Loosen the two arm screws further to remove them from the arm holders.

2. Set the arm holders to the desired angle.

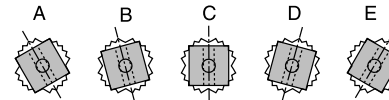
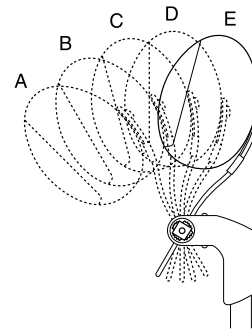

At time of shipping, the arm is mounted at angle D.

- ① Take one of the arm holders, rotate it any of the angles A to E indicated at left, and place it back into the opening such that the corners of the arm holder match the ridges on the opening.
 - Please do not set the arm holders to any angle other than A to E. The speaker may not be stable (and is likely to tip over) if mounted at an angle outside of this range.
- ② Loosely fasten the holder in place with the arm screw.
 - Don't tighten the screw all the way. Tighten only enough so that the arm holder stays in position at the selected angle.
- ③ Now set the other arm holder (the holder on the other side) to the same angle, and loosely fasten it with the arm screw.

3. Insert and fasten the arm.

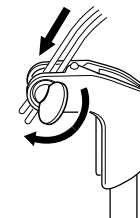

- ① Fit the arm through the openings in the arm holders and adjust to the desired height. Then tighten the two arm screws to lock the arm in place.
- ② Replace the screw caps.
- ③ Reconnect the speaker cord to the jack.

You may now want to readjust the angle of the speaker on the arm. You can do this by loosening the screw holding the speaker to the arm, repositioning the screw, and then retightening it. See "Adjusting the Speaker Angle," on page 8.

Other Ways to Set Up the Satellite Speakers

LSF-1010 (EN)

As an alternative to the standard setup, you can also mount the satellite speakers in any of the following configurations.

- Sideways on the stand ("Offset mount")
- On the wall ("Wall mount")
- Without the stand ("Clip-on mount")

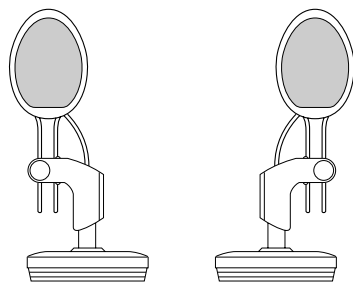

Offset Mount

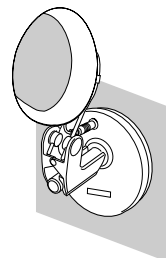

Wall Mount

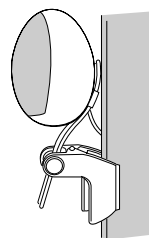

Clip-On Mount

Offset Mount

For information about how to remove/replace the screw caps and loosen the arm screws, see page 16, "Getting Ready to Adjust."

1. Remove the arm.

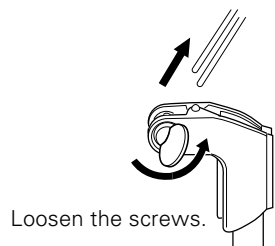

Loosen the screws.

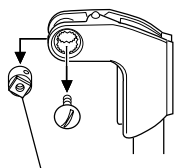

Arm holders

Remove the screws from the arm holders.

- ① Loosen the two arm screws and pull the arm out.

- Unplug the cord from the jack before removing the arm.

- ② Further loosen the arm screw on the side that you want to mount the arm, so that the arm screw and arm holder come out.

2. Set the arm holder to vertical position.

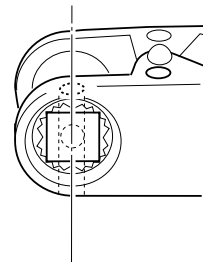

- ① Position the arm holder that you just removed so that the hole in the holder is vertical (facing directly up/down), and set it back into the holder opening.

- ② Loosely fasten the holder in place with the arm screw.

- Don't tighten the screw all the way. Tighten only enough so that the arm holder stays in position at the selected angle.

3. Attach and fasten the arm.

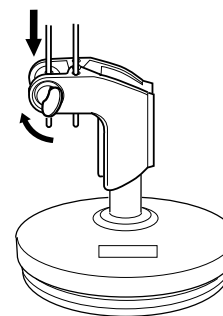

- ① Set the arm so that one rib of the arm holder goes through the hole in the arm holder, and the other rib fits through the hole in the top of the clip. Set the arm to the desired height, and tighten the arm screw all the way to lock the arm in place.

- ② Turn around the arm as shown, and fit the clip onto the pole.

- ③ Tighten up the arm screw on the other side.

- ④ Place the screw caps back over the arm screws.

- ⑤ Reconnect the speaker cord to the jack.

You may now want to readjust the angle of the speaker on the arm. You can do this by loosening the screw holding the speaker to the arm, repositioning the screw, and then retightening it. See "Adjusting the Speaker Angle," on page 8.

Wall Mount

You can mount the satellite speaker stands on the wall as described below.

Precautions

Please observe the following precautions when mounting speaker stands onto the wall.

- Be sure that the wall you are using is strong enough to support the full weight of the speaker and stand (approx. 650 g [1.4 lb]).
- Wall screws must be purchased separately. Be sure to use screws that are appropriate for the wall you are using, and that are long enough to provide sufficient strength.
- If you are uncertain about the wall's support strength, the type of screw to use, or any other points regarding this type of installation, please consult a contractor or other qualified person before proceeding.

Be sure to follow the procedure given here when carrying out installation. Kenwood can assume no liability for injury or damage that may occur if a speaker setup falls from the wall as a result of incorrect installation or insufficient support strength.

For information about how to remove/replace the screw caps and loosen the arm screws, see page 16, "Getting Ready to Adjust."

1. Remove the arm.

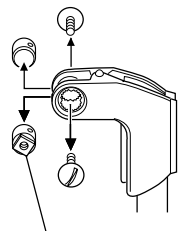
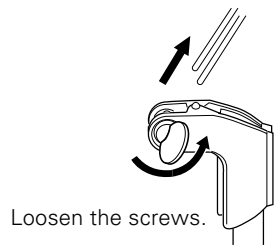

Arm holders

Remove the screws from the arm holders.

- ① Loosen the two arm screws and pull the arm out.
 - Unplug the cord from the jack before removing the arm.
 - Be sure to remove the clip from the pole before proceeding to mount the stand onto the wall. The clip may become stressed or damaged if left in place during the next few steps.
- ② Loosen the two arm screws further to remove them from the arm holders.

2. Set the arm holders to the desired angle.

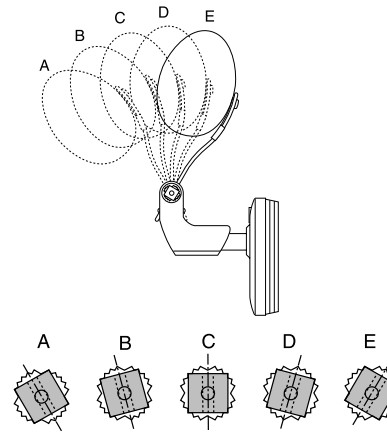

- ① Take one of the arm holders, rotate it to the desired angle, and place it back into the opening.
- ② Loosely fasten the holder in place with the arm screw.
 - Don't tighten the screw all the way. Tighten only enough so that the arm holder stays in position at the selected angle.
- ③ Now set the other arm holder (the holder on the other side) to the same angle, and loosely fasten it place with the arm screw.

3. Attach speaker cord to the base.

- ① Use a coin or screwdriver to turn loosen the screws.
- ② Remove the plastic insulation from each wire tip, and twist the exposed metal wire.
- ③ Curl the wire around the thin part of the corresponding screw, and then tighten the screw.
Be sure that the screw head makes contact with metal only, not with plastic insulation.

- ① Connect the included speaker cord.

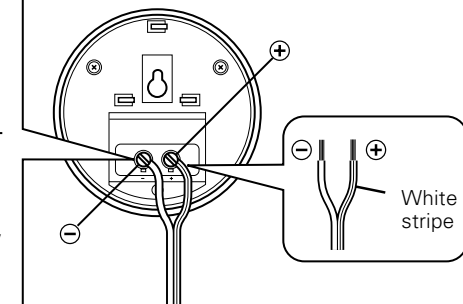

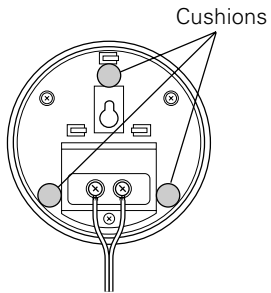

4. Reattach the clip to the pole.

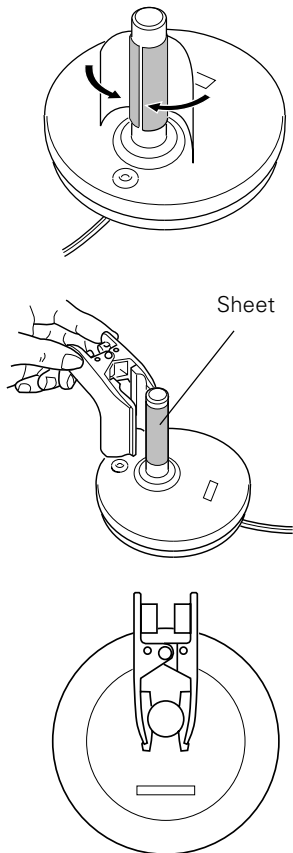

② Attach supplied cushions to the bottom of the stand base.

- The cushions will create a gap between the wall and the base through which speaker cord can pass. Please do not neglect to attach the cushions.

① First adhere the non-slip sheet onto the pole.

- Wrap the sheet around the pole as shown in the illustration.

② Attach the clip to the stand.

- Fit the clip securely onto the pole in the position shown in the illustration.

5. Attach and fasten the arm.

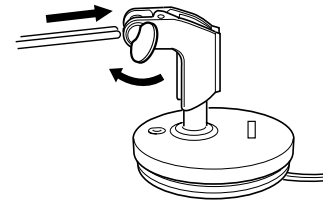

- ① Fit the arm through the holes in the arm holders, adjust it to the desired height, and then tighten the arm screws.
- ② Place the screw caps back over the arm screws.
- ③ Reconnect the speaker cord to the jack.

You may now want to readjust the angle of the speaker on the arm. You can do this by loosening the screw holding the speaker to the arm, repositioning the screw, and then retightening it. See "Adjusting the Speaker Angle," on page 8.

6. Mount the stand onto the wall.

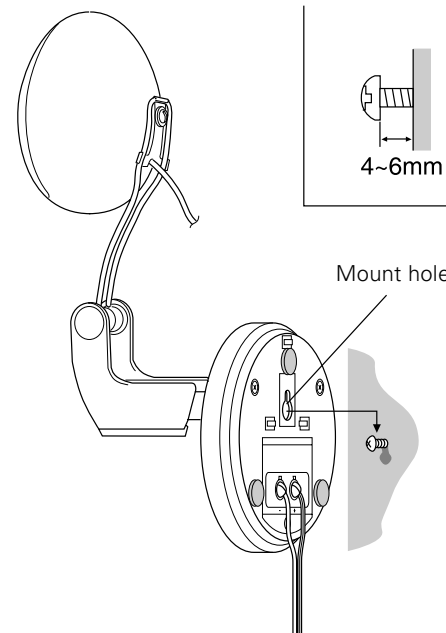

- ① Screw a wall screw into the location on the wall where you want to mount the speaker. Allow the head of the screw to project 4 to 6 millimeters (about 3/16 to 1/4 inch) from the surface of the wall.

- Wall screws are not included.

- ② Mount the base onto the wall by fitting the mount hole (on the bottom of the base) over the projecting screw head. Be sure that the base is mounted securely.

LSF-1010 (EN)

Clip-on Mount

Use the following procedure to clip the speaker onto an object other than the base. You can clip to either a cylindrical fixture (such as a thin pipe) or a flat-edge fixture (such as the edge of a bookshelf).

Conditions

- If flat: Width should be 12 to 15 mm (about 0.5 to 0.6 inches)
- If cylindrical: Diameter should be 12 to 20 mm (about 0.5 to 0.8 inches).

For information about how to remove/replace the screw caps and loosen the arm screws, see page 16, "Getting Ready to Adjust."

1. Remove the arm.

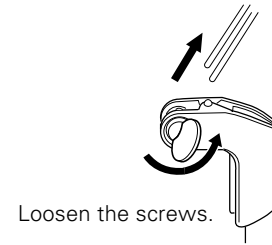

- ① Loosen the two arm screws and pull the arm out.
 - Unplug the cord from the jack before removing the arm.
 - If you want to change the angle of the arm, set the arm holders to the appropriate angle. For instructions, see page 17, "Adjusting the Arm Angle."

2. Clamp the clip onto an appropriate object.

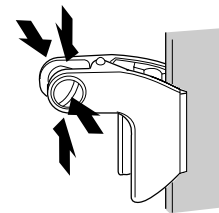
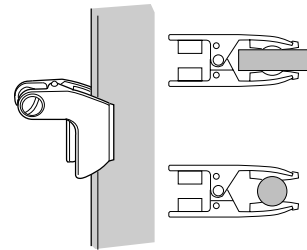

- ① Unclamp the clip from the stand, and clamp it onto an appropriate flat edge or cylinder.
 - If clipping to a flat edge, set so that the entire rubber part of the clip makes contact with the flat surface.
 - If clipping to a cylinder, set so that the rubber part fits (curves) around the cylinder.
- ② Gently push the clip up, down, right, and left to confirm that it is securely fixed in place and maintains its position. Many objects are not suitable as supports — either because the material is not strong enough or because the surface does not allow an adequate grip. Do not clip to any object that does not offer sufficient stability.

(To be continued.)

3. Attach and fasten the arm.

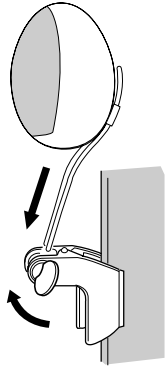

- ① Fit the arm through the holes in the arm holders, adjust it to the desired height, and then tighten the arm screws.
- ② Place the screw caps back over the arm screws.

You may now want to readjust the angle of the speaker on the arm. You can do this by loosening the screw holding the speaker to the arm, repositioning the screw, and then retightening it. See "Adjusting the Speaker Angle," on page 8.

4. Connect the satellite speaker to the base of the stand using separately purchased extension speaker cord.

- Use cord that has a mini-plug (3.5-mm) at one end and a mini-jack (3.5-mm) on the other. Do not connect the wire from the speaker directly to an amp; the connection must be relayed through the base.

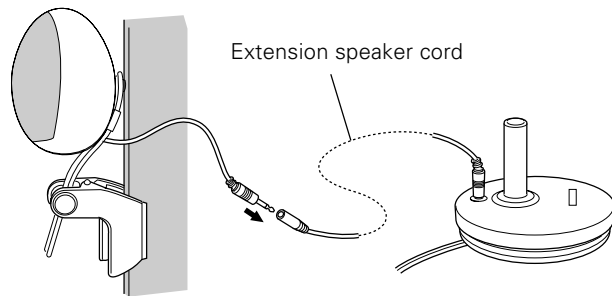

Cleaning

You can clean the panel for subwoofer and satellite speaker and casing by wiping with a soft cloth. Never clean with alcohol, benzene, paint thinner, or other such solvents, as these may cause discoloration.

Contact Restorers

Never use contact restoring agents to restore electrical connections, as these may cause the subwoofer to fail. Agents that include oil may in addition lead to deformation of the plastic.

Removing and Reattaching the Screen

Use the following proceeding to remove or reattach the subwoofer's front screen.

1. To remove the screen:

- ① Gently pull the bottom of the screen so that it comes free of the subwoofer.
- ② Hold the top of the screen and pull it, so that the screen comes off.

2. To attach the screen:

- ① Attach the top of the screen first. Hold the screen so that the pegs (at the top right and left) are aligned with the corresponding holes on the superwoofer, and push in to attach.
- ② Push the lower corners to attach the screen at the bottom.

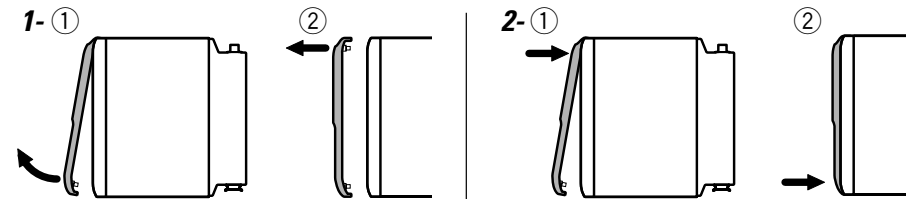

If the subwoofer does not seem to be working correctly, the following advice may help you correct the problem.

Problem	Possible Cause	Correction	See page...
No sound.	<ul style="list-style-type: none"> * Wires are not securely connected. * The volume is turned all the way down. * The amp or receiver's SUBWOOFER PRE-OUT signal is switched off. (Applies only if your amp or receiver includes a pre-out on/off switch.) 	<ul style="list-style-type: none"> * Connect the wires securely. (Refer to "Making Connections.") * Raise the volume to an appropriate level. * Switch on the SUBWOOFER PRE-OUT signal at the amp or receiver. 	<p>10 14</p>
Volume is too low.	<ul style="list-style-type: none"> * Speaker cords are reversed. * The phase setting is not appropriate. * The amp or receiver's PRE-OUT level is set to the minimum. (Applies only if your amp or receiver includes a pre-out level adjustment.) 	<ul style="list-style-type: none"> * Reconnect so that L, R, (+), and (-) connections are correct. (Refer to "Making Connections.") * Change the setting of the PHASE switch. * Raise the PRE-OUT level at the amp or receiver. 	<p>10 14</p>
Noise in AM reception.	<ul style="list-style-type: none"> * The subwoofer is placed too close to the AM receiver. 	<ul style="list-style-type: none"> * Move the subwoofer from the AM receiver. 	<p>7</p>

Satellite speaker

System	Full-range Speaker System (Magnetically shielded)
Enclosure	Acoustic Air Suspension type
Loudspeaker	50 mm (2 ") Cone type
Nominal Impedance	6 Ω
Peak Input Power	60 W
Maximum Input Power	40 W
Sensitivity	80 dB/W at 1 m
Frequency Response	200 Hz to 20,000 Hz
Dimensions (*1).....	Width : 114 mm (4-1/2 ") Height : 280 mm (11 ") Depth : 130 mm (5-1/8 ")
Net Weight (*2)	650 g (1.4 lb) / piece

*1: Dimensions may vary depending on the setting up of the satellite speakers.

*2: Stand included.

Subwoofer

System	Subwoofer system with built-in amplifier (Magnetically shielded)
[Audio section]	
Rated Output Power	40 W DIN (300 Hz, 6 Ω)
Output Power	50 W RMS (300 Hz, 10%, 6 Ω)
Input Sensitivity / Impedance	
RCA-type pin-plug jack (LINE IN)	70 mV / 20 k Ω 140 mV / 20 k Ω (MONO)
Push-type terminals	1.4 V / 10 k Ω
Turnover frequency	80 Hz to 400 Hz
Phase Switching	NORMAL, REVERSE
[Speaker section]	
Enclosure	Bass-reflex type (Passive radiator system)
Loudspeakers	
Driver	100 mm (4 ") Cone type
Passive radiator	125 mm (5 ")
Nominal Impedance	6 Ω
[General]	
Power Consumption	95 W
Frequency Response	40 Hz to 800 Hz (at 400Hz turnover frequency)
Dimensions	Width : 160 mm (6-5/16 ") Height : 270 mm (10-5/8 ") Depth : 274 mm (10-13/16 ")
Net Weight.....	4.4 kg (9.7 lb)



- 1.KENWOOD follows a policy of continuous advancements in development. For this reason specifications may be changed without notice.
- 2.Sufficient performance may not be possible at very low temperatures (0°C or less).

KENWOOD

For your records

Record the serial number, found on the back of the subwoofer, in the spaces designated on the warranty card, and in the space provided at right. Refer to the model and serial numbers whenever you call upon your dealer for information or service on this product.

Model

Serial Number